

R&S® EB500

Monitoring Receiver

Powerful and compact

4TECT

ООО «4TECT»

Телефон: +7 (499) 685-4444

info@4test.ru

www.4test.ru

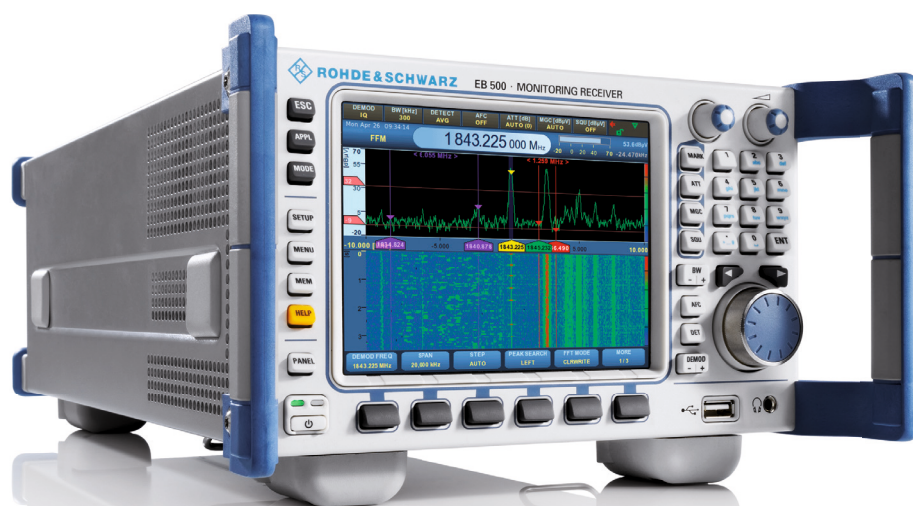

R&S®EB500 Monitoring Receiver At a glance

The R&S®EB500 monitoring receiver was specially developed for signal search, radiomonitoring, radio detection and spectrum monitoring in powerful, compact systems. Due to the receiver's compact size as well as its excellent performance and energy-saving design, it is the perfect tool for radiomonitoring applications. It performs ITU-compliant measurements and meets the requirements of security authorities and organizations. The receiver is ideal for both stationary and mobile/vehicular applications because it can be operated via the front panel or remotely controlled via LAN.

The R&S®EB500 features a wide frequency range (8 kHz to 6 GHz), outstanding receive characteristics, 20 MHz realtime bandwidth and a wealth of functions.

Thanks to its sophisticated preselection stages, the receiver can be directly connected to a wideband monitoring antenna. This is an operating scenario that requires high large-signal immunity and high sensitivity, particularly in the presence of many strong signals.

An upgrade kit is available to turn the monitoring receiver into a high-performance, single-channel direction finder.

All results are output via the receiver's LAN interface, including:

- Spectra (realtime operation and scan mode)
- Waterfall (spectrogram)
- Demodulated audio information
- Level measurement data
- I/Q baseband data

Key facts

- ITU-compliant measurements and applications for security authorities and organizations
- Wide frequency range: 8 kHz to 6 GHz (base unit: 20 MHz to 3.6 GHz)
- 20 MHz realtime bandwidth
- Numerous options to increase performance
- Various result displays
- Integration into customer-specific software packages from third-party suppliers thanks to open, documented, remote control interface and data formats
- Internal recording and replay of spectra and waterfall data (for receivers with front panel operation or for external R&S®EB500-GUI software)
- Map display with GPS position (for receivers with front panel operation or for external R&S®EB500-GUI software)

R&S®EB500 with display.

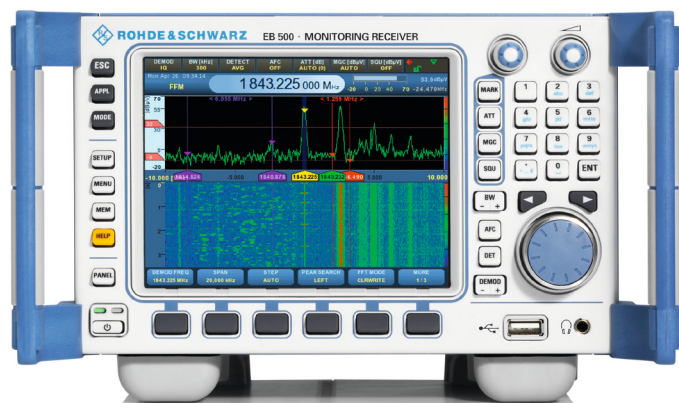

R&S®EB500 without display.



R&S®EB500

Monitoring Receiver

Applications

Searching for interference sources in the air traffic control (ATC) band

- Fast detection and elimination of interfering signals to maintain security-critical aeronautical radiocommunications
- Monitoring of entire aeronautical radio band (approx. 20 MHz) within realtime spectrum
 - Easy detection of pulsed, frequency agile or sporadic interferers
- Audio monitoring of occupied channels to check audio transmission quality using the frequency scan

▷ [page 7](#)

Handoff receiver in a networked system

- Parallel demodulation of multiple narrowband signals and simultaneous broadband spectrum scanning
- Handover of a signal from the search receiver to the handoff receiver

▷ [page 8](#)

Nationwide networked system for ITU-compliant radiomonitoring

- Networking of radiomonitoring nodes of civil regulatory authorities, e.g. with R&S®ARGUS and suitable options
- Automatic identification of deviations between actual and predefined spectral values
- Guided measurements with R&S®ARGUS – even for inexperienced users
- Audio demodulation and processing

▷ [page 9](#)

Radiomonitoring for security authorities and organizations

- Networking of several receiving stations to create a temporary networked system, e.g. with R&S®RAMON and suitable options
- Multiple receiver concept: parallel search, detection and generation of content
- Central control station to ensure the operational success of security authorities and organizations

▷ [page 10](#)

Signal analysis of a communications channel with unknown content

- Online signal analysis with live streaming over LAN interface, e.g. with R&S®CA100 and suitable options
 - Signal analysis and classification
 - Detection of modulation mode and transmission quality (eye diagram)
 - Extraction of signal content using bitstream analysis
- Offline signal analysis of recordings

▷ [page 11](#)

R&S®EB500

Monitoring Receiver

Benefits and key features

Frequency range from 8 kHz to 6 GHz

- One monitoring receiver for “all” frequencies
- Base unit: 20 MHz to 3.6 GHz
 - R&S®EB500-HF: option for HF signal reception from 8 kHz
 - R&S®EB500-FE: option for SHF signal reception up to 6 GHz
- Same size, even with all frequency options installed (½ 19" width, 3 HU)

▷ [page 12](#)

Integrated antenna switch

- Two separate inputs for HF (1) and HF/VHF/UHF/SHF (1)
- Automatic switching between antennas as a function of selected frequency, even during scanning

▷ [page 12](#)

Powerful preselection: large-signal immunity and high sensitivity

- Reliable protection against overloading due to strong signals
- Outstanding sensitivity due to high-gain preamplifier stage
- Ideal monitoring receiver with wide dynamic range for all signal scenarios
- Smooth operation, e.g. with a wideband receiving antenna (responsible for high total signal load at receiver input)

▷ [page 12](#)

FFT signal processing with 20 MHz realtime bandwidth

- Realtime spectrum for detecting pulsed or frequency agile signals
- FFT signal processing for fine frequency resolution and high sensitivity
- FPGA implementation for top processing speed with fine resolution and sensitivity

▷ [page 13](#)

Extremely fast spectral scan (panorama scan) across entire frequency range

- R&S®EB500-PS option: extremely fast FFT scan
- Fast spectrum overview at fine resolution bandwidth
- Combination of spectral results and waterfall display
- Optimal determination of frequency range of interest from an unknown starting position

▷ [page 14](#)

Waterfall diagram for examination of signal history

- Three-dimensional display of spectrum over frequency, time and color-coded signal level
- History mode function to stop the waterfall and display a previous spectrum
- Outstanding visual presentation of pulsed or frequency agile signals
- Settable time resolution of waterfall (speed)

▷ [page 14](#)

Recording of spectra and waterfall data and replay of results

- Recording of spectra and waterfall data, e.g. on a USB flash drive
- Replay of recorded content for detailed evaluation of signals contained in spectrum
- Identical receiver and parameter settings in recording and replay modes
- For receivers with front panel operation or for external R&S®EB500-GUI software

▷ [page 15](#)

Map display with GPS position

- Map display of current receiver location
- Selectable display of recorded results (e.g. spectra) relative to a position
- Map material based on OpenStreetMap (OSM)
- For receivers with front panel operation or for external R&S®EB500-GUI software

▷ [page 15](#)

Polychrome spectrum to distinguish superimposed, pulsed signals

- Display of time behavior (frequency of occurrence) of pulsed signals using color coding (for all realtime bandwidths)
- Settable occurrence frequency threshold
- Separate display of pulsed signals (superimposed in frequency, time and level)

▷ [page 16](#)

Video spectrum for display of subcarriers and transmission rates

- Spectrum display of demodulated signal
- Clear display of subcarriers, e.g. 19 kHz pilot tone
- Squared video spectrum to estimate the transmission rate (baud rate) of a digitally modulated signal
- Combination of spectral results and waterfall display

▷ [page 17](#)

Parallel signal processing of spectral path and demodulation path

- Two parallel signal processing paths for spectrum and demodulation
- Interference-free demodulation with parallel display of realtime spectrum and waterfall display
- Seamless I/Q baseband data stream for signal analysis
- Independent setting of bandwidth and center frequency

▷ [page 18](#)

Level measurements with “real” wideband detector

- Wideband level measurements up to 20 MHz bandwidth for sophisticated, digitally modulated signals

▷ [page 19](#)

Frequency scan and memory scan for audio demodulation on changing channels

- Frequency scan: continuous scanning of adjacent channels, automatic demodulation of channels where level exceeds squelch, e.g. in ATC band
- Memory scan: scanning of different radio services with variable step size and demodulation mode
- Convenient scanning for active signals and quick availability of audio content

▷ [page 19](#)

3+1 receivers in one instrument

- R&S®EB500-DDC option: three additional demodulation channels
- Four software receivers in one instrument thanks to four demodulation channels (anywhere within realtime bandwidth)
- Output of demodulated data as separate data streams via LAN interface

▷ [page 20](#)

Ethernet interface for remote control and/or data transmission

- 1 Gbit Ethernet LAN interface for receiver remote control and result processing using Rohde&Schwarz system software (e.g. R&S®ARGUS, R&S®RAMON, R&S®CA100)
- Documented interface description for flexible programming and data processing, even with customer-specific software package

▷ [page 20](#)

Receiver remote control and data recording

- R&S®EB500-Control software package for receiver remote control via 1 Gbit LAN interface
- Documentation of results on a PC (e.g. spectra or audio content), also for replaying recorded data for offline analysis

▷ [page 21](#)

ITU-compliant measurements in the receiver

- R&S®EB500-IM option: ITU-compliant measurement of signal parameters for AM, FM and PM-modulated signals (e.g. modulation index, occupied bandwidth and phase deviation)
- Offline measurement of digitally modulated signals using the R&S®CA100IS software and suitable options (in line with ITU recommendation SM.1600)

▷ [page 22](#)

Detection of selective call services

- R&S®EB500-SL option: detection of audio-based selective calls and listing of received selective call standards
- Result filtering according to relevant standards

▷ [page 23](#)

DC operation (e.g. from vehicle battery)

- DC power supply (10 V to 32 V DC) of receiver
- Space-saving vehicle installation

▷ [page 23](#)

System time synchronization using NTP server

- Time and date synchronization using an NTP server for simultaneous control of multiple receivers in a networked system
- Easy comparison of measurement results received by different stations

▷ [page 23](#)

TDOA ready with high-accuracy timestamps and GPS synchronization of frequency and time

- R&S®EB5-EGT option: synchronization of receiver frequency and time using external GPS module
- High-accuracy timestamps in I/Q baseband data stream, ideal for use in TDOA systems

▷ [page 24](#)

Single-channel direction finder upgrade kit

- R&S®EB500-DF option: upgrade to single-channel direction finder
- Direction finding of signals in frequency range up to 6 GHz
- Reliable DF results even in difficult environments (e.g. urban areas with up to 50% reflection)
- Parallel direction finding of all emissions within 20 MHz realtime bandwidth

▷ [page 25](#)

Documentation of calibration values

- R&S®EB500-DCV option: documentation of calibration values with calibration certificate from final production testing for a specific serial number
- Calibration label for instrument

▷ [page 25](#)

Searching for interference sources in the air traffic control (ATC) band

Fast detection and elimination of interfering signals to maintain security-critical aeronautical radiocommunications

The ATC radio band contains all security-critical radiocommunications necessary to control national and international aircraft movements. Interference in this approx. 20 MHz wide frequency spectrum can quickly lead to critical situations. It is necessary to constantly monitor this frequency range in order to quickly detect and eliminate unauthorized emissions and wideband interference.

Monitoring of entire aeronautical radio band (approx. 20 MHz) within realtime spectrum

Thanks to its 20 MHz realtime processing, the R&S®EB500 is ideal for continuous monitoring of the ATC band. A combination of realtime spectrum and waterfall diagram allows users to easily detect even short-term emitters (e.g. PTT radios) and frequency agile signals (e.g. in frequency hopping modems). Sporadic wideband interference (e.g. caused by defective large format screens) is clearly displayed in the waterfall diagram, a fast and convenient way of showing the user where interference is causing problems.

Audio monitoring of occupied channels to check audio transmission quality using the frequency scan

The R&S®EB500 frequency scan constantly monitors all ATC channels for emissions. If channel occupancy is detected (level exceeds squelch), the receiver dwells on this channel for a preset period of time and outputs the demodulated audio information. This enables users to quickly and easily check if there is audible interference on one or more channels and initiate appropriate countermeasures.

Interference in radiocommunications, e.g. at airports, not only impedes operation – it may even pose a threat to life.



Handoff receiver in a networked system

Parallel demodulation of multiple narrowband signals and simultaneous broadband spectrum scanning

Multiple R&S®EB500 receivers can be combined with a fast and powerful search receiver (e.g. the R&S®ESMD) and operated as a system. The handoff receiver (R&S®EB500) demodulates signals and produces audio or I/Q data streams, while the search receiver quickly searches for other signals with an extremely high level of sensitivity. A separate handoff receiver is required for each signal to be processed in parallel.

Handover of a signal from the search receiver to the handoff receiver

The handover of a signal from the R&S®ESMD (search receiver) to an R&S®EB500 (handoff receiver) can be carried out from the user workstation running the R&S®RAMON radiomonitoring software. The major advantage of this system configuration is that fast signal scanning across a wide frequency range takes place at the same time as narrowband generation of multiple audio or I/Q data streams. This allows the user to achieve optimum results in a minimum of time.

Networked system: Multiple R&S®EB500 receivers can be operated together with an R&S®ESMD.



Nationwide networked system for ITU-compliant radiomonitoring

Networking of radiomonitoring nodes of civil regulatory authorities

To perform civil regulatory authorities' radiomonitoring tasks in line with ITU recommendations, all available receiving nodes must be networked. This includes both stationary and vehicular radiomonitoring stations. The R&S®ARGUS monitoring software is ideal for networking and remotely controlling nationwide radiomonitoring systems as well as small regional networks. Interference can be quickly and effectively located and eliminated, even in a frequency spectrum with steadily increasing occupancy (e.g. police radio, VHF radio, aeronautical radio, DECT, radio for security authorities and organizations, mobile phones and WLAN).

Continuous, networked monitoring is the only way to ensure smooth operations in dense radiocommunications traffic.

Automatic identification of deviations between actual and predefined spectral values

Deviations between actual spectral values and a predefined mask are automatically identified, allowing differences in the signal scenario to be quickly and conveniently detected. If one of the measurement parameters is outside the defined value range, the R&S®ARGUS software immediately generates an automatic alarm message. This type of user-friendly parameter identification is in line with ITU recommendations and can be used to identify interfering signals, detect unlicensed emissions, verify compliance with applicable licenses and much more.

Guided measurements with R&S®ARGUS – even for inexperienced users

One notable R&S®ARGUS feature is the “guided measurement” function. The user selects a measurement task (e.g. measurement of field strength or occupied bandwidth), and R&S®ARGUS automatically configures the appropriate parameters of the selected monitoring receiver. It also automatically selects the receiving antenna based on the selected frequency range and required polarization. Thanks to this convenient function, even inexperienced users can effectively operate the R&S®EB500 monitoring receiver.

Audio demodulation and processing

Received and demodulated audio content is recorded and can be output online over the operating station's loudspeakers to ensure that different stations are monitoring the same signal. The impact of interferers on traffic channels transmitting audio content is also documented.

Spectrum of a DVB-T transmitter with a mask overlay.

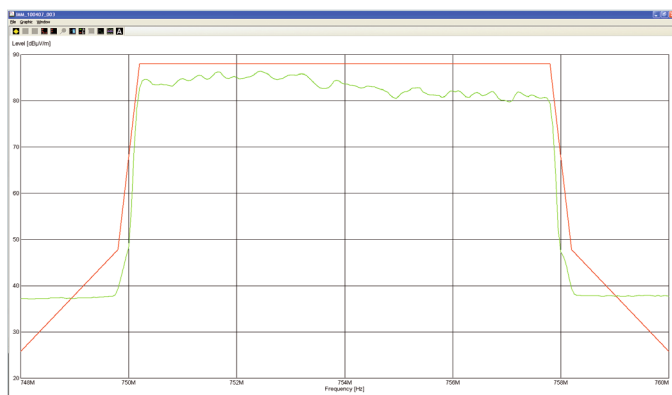

Radiomonitoring for security authorities and organizations

Networking of several receiving stations to create a temporary networked system

Monitoring station setups must be flexible in order to support localized radiomonitoring tasks in both stationary and mobile applications. The R&S®RAMON radiomonitoring software was specially developed for networking receiving stations to create a temporary networked system. The software optimizes radiomonitoring of security-critical zones, for example by collecting spectra or demodulated audio content.

Multiple receiver concept: parallel search, detection and generation of content

In a typical system scenario, one or more fast search receivers are used to detect and display unknown emissions in the spectrum. If a receiver detects a signal of interest, R&S®RAMON passes it on to another receiver for demodulation and signal analysis. These receivers are operated in parallel in a networked system. As a result, the fast search receivers are not blocked by the time-consuming generation of data content. They are always available to search for new signals.

Central control station to ensure the operational success of security authorities and organizations

The R&S®RAMON software enables users to connect to different receiving nodes from a central control station. Depending on the operating scenario, users always receive information from the receiver located closest to the signal source of interest. This is particularly important for security authorities and organizations because they often have to respond to changing transmitters.

Fast spectral scan of the GSM900 band with max. hold function and waterfall diagram (GSM and LTE signals visible).

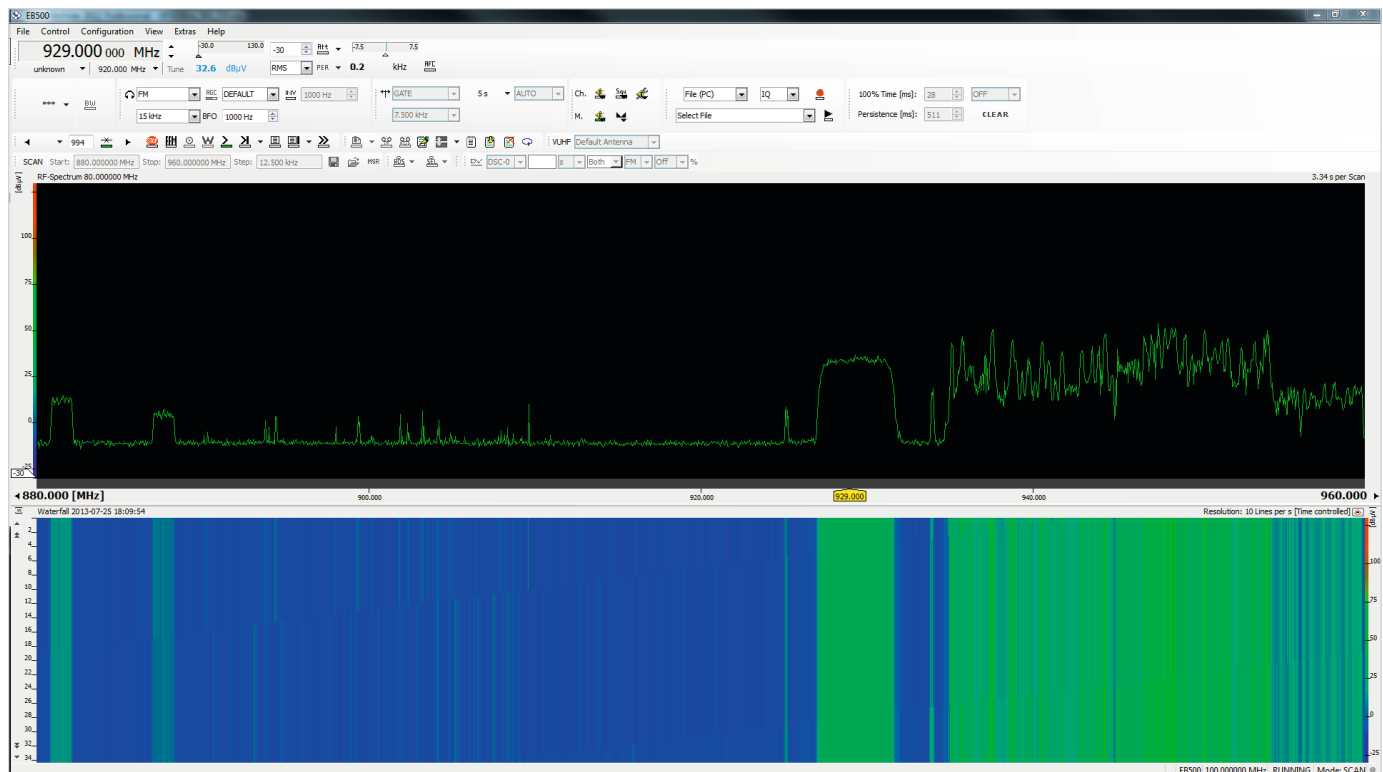

Signal analysis of a communications channel with unknown content

Online signal analysis with live streaming over LAN interface

The R&S®EB500 provides a continuous I/Q baseband data stream for online analysis of a max. 1 MHz signal channel over the 1 Gbit LAN interface. The R&S®CA100 software uses this data stream to analyze and classify the signal on an external PC. It recognizes modulation modes and displays transmission quality in an eye diagram. Bitstream analysis allows users to extract the message content from the received signal.

If the monitoring receiver is equipped with DDCs (R&S®EB500-DDC option), the R&S®CA100 software can process up to three signals in parallel.

Offline signal analysis of recordings

The R&S®CA100 software can save data packets on a PC's hard disk for later detailed offline analysis. Complex signal forms are examined under different conditions to obtain more detailed analysis results.

Online and offline signal analysis, from eye diagram to message content.



Benefits and key features

Frequency range from 8 kHz to 6 GHz

Thanks to its wide frequency range from 8 kHz to 6 GHz, the R&S®EB500 is a “receiver for all frequencies”. The size of the R&S®EB500 (½ 19" width, 3 HU) does not increase – even with all frequency options installed. The compact receiver can be placed on the desktop or installed in a 19" rack (e.g. for installation in vehicles).

The R&S®EB500 offers the following receiving frequency ranges:

- Base unit: 20 MHz to 3.6 GHz
- R&S®EB500-HF option: 8 kHz to 32 MHz
- R&S®EB500-FE option: 3.6 GHz to 6 GHz

Integrated antenna switch

Thanks to the integrated antenna switch, the receiver can be operated with multiple antennas. The following antenna inputs are available on the receiver's rear panel:

- Combined HF/VHF/UHF/SHF input (8 kHz to 6 GHz)
- Separate HF input (8 kHz to 32 MHz)

The right antenna is automatically selected based on the frequency set in the receiver. Antennas and frequency ranges are defined using the receiver's menus. The antenna switching matrix is also controlled during scanning, eliminating the need for an external switching matrix and additional hardware and software.

Powerful preselection: large-signal immunity and high sensitivity

The R&S®EB500 receiver's powerful preselection stage reliably protects it against overloading due to strong input signals. The R&S®EB500 also features an internal high-gain preamplifier stage and offers excellent receiver sensitivity.

Integrated antenna switching matrix



For simultaneous connection of different receiving antennas

Powerful preselection



R&S®EB500

A 10 dB higher sensitivity means 3.3 times the distance to the signal source.
The signal remains visible on the receiver (assuming the same large-signal immunity for both instruments).

The resulting wide dynamic range makes the R&S®EB500 the ideal monitoring receiver for all signal scenarios.

Large-signal immunity and high sensitivity (in the same operating mode, e.g. normal mode) are absolutely necessary monitoring receiver characteristics in order to ensure smooth operation, e.g. with a wideband receiving antenna. Wideband antennas pose a significant challenge in the design of a receiver's frontend. It is often necessary to scan for weak signals while receiving multiple strong signals at a similar frequency.

The figure at the bottom of page 12 shows the effect of a receiver with 10 dB higher sensitivity (compared with receiver X). To obtain a practicable comparison, the same or similar large-signal immunity is assumed for both instruments.

FFT signal processing with 20 MHz realtime bandwidth

Realtime processing of the frequency spectrum is essential for detecting pulsed or frequency agile signals. FFT signal processing allows all spectral information to be displayed simultaneously. The realtime spectrum is calculated without sweeping or scanning and offers detection in realtime. The calculation time is negligible due to FPGA implementation.

FFT realtime processing also offers excellent frequency resolution plus very high sensitivity.

This combination of speed, frequency resolution and sensitivity makes the receiver ideal for a very wide range of applications. Users get detailed information about the frequency spectrum. Pulsed, time-variant and frequency agile signals are reliably detected and displayed in the spectrum or waterfall diagram. During realtime operation, signals can be demodulated in parallel, without interruptions.

The R&S®EB500 base unit features a realtime bandwidth of 20 MHz. Depending on the requirements, the realtime spectrum span can be stepwise reduced to a minimum bandwidth of 1 kHz.

A detailed description of R&S®EB500 realtime processing is available in the "Realtime FFT processing in Rohde&Schwarz receivers" application brochure (PD 3606.8308.92).

Strong activity in the 2.4 GHz ISM band caused by WLAN and Bluetooth® signals (superimposed in frequency and time; can be unambiguously identified using the realtime spectrum).



Extremely fast spectral scan (panorama scan) across entire frequency range

To search for signals outside the realtime bandwidth, the R&S®EB500 offers an extremely fast spectral scan function, the panorama scan (R&S®EB500-PS option). This scan function is also based on FFT calculation for very high scan speed, extremely fine resolution and high sensitivity. Spectral results can be combined with the waterfall diagram. This is particularly useful when searching for pulsed or frequency agile signals. Signals cannot be demodulated during an ongoing scan.

The panorama scan is ideal for determining the frequency range of interest from an unknown starting position, for example based on the interference contained. The R&S®EB500 is then switched to realtime mode for in-depth analysis.

A detailed description of R&S®EB500 realtime processing is available in the “Realtime FFT processing in Rohde&Schwarz receivers” application brochure (PD 3606.8308.92).

Detection of a hopper signal in the 5.8 GHz ISM band using the fast spectral scan over the 1 GHz bandwidth.



Waterfall diagram for examination of signal history

The waterfall diagram (spectrogram) provides a three-dimensional display of the spectrum over frequency, time and color-coded signal level.

This diagram is used to search for pulsed, frequency agile signals and signals that occur at statistically irregular intervals. The outstanding visual presentation of these signals in the waterfall diagram make this display an indispensable tool for any intercept operator.

The user can set the time resolution in the waterfall (equivalent to speed), which must be adjusted to the current signal scenario. Markers can be used to analyze time correlations in the waterfall diagram.

Short-term signals are clearly displayed in the waterfall diagram for easy identification by the user.

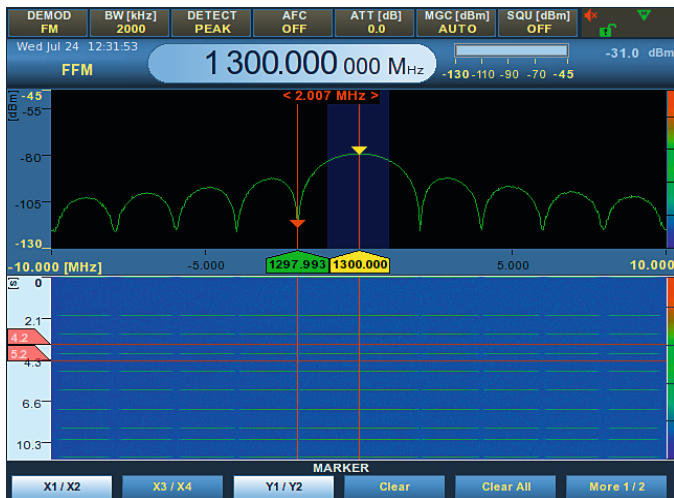

This function is included in the base unit.

Recording of spectra and waterfall data and replay of results

For detailed evaluation of detected signals, a given spectral/waterfall scenario must be recorded (e.g. on a connected USB flash drive) to be able to replay the information later in the receiver (R&S®EB500-IR option).

This makes it possible to evaluate detected events (e.g. up to 20 MHz realtime spectra or panorama scan spectra covering several GHz) by type and relevance. This function provides useful support when searching for interference or documenting a previously recorded signal, for example. A set of relevant signals can be collected for subsequent examination.

Using this option, the demodulated audio content (or I/Q data for digitally modulated signals) in the corresponding spectrum can be recorded simultaneously. In replay mode, the source of the interference can be precisely identified by evaluating the impaired audio content and the corresponding spectrum in parallel.

Recorded ATC signals can be evaluated offline.

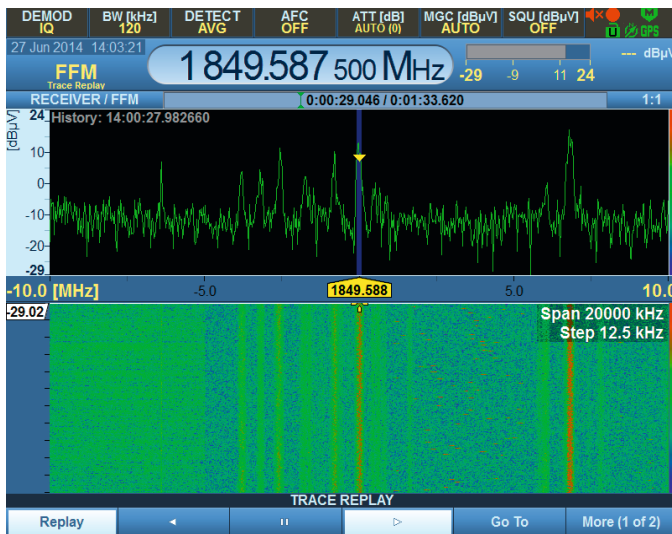

The positions recorded during a drive test (including the bearing, if applicable) are shown on a map.

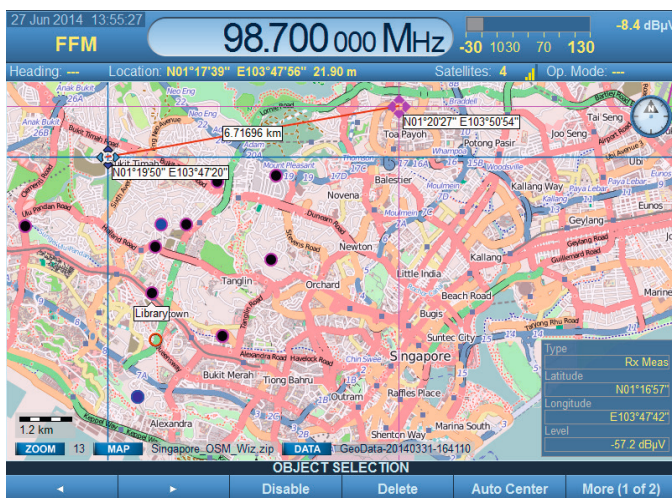

The R&S®EB500-IR internal recording option is available for receivers with front panel operation (model .03) or for external R&S®EB500-GUI software.

Map display with GPS position

If the receiver is operated in nonstationary mode (e.g. vehicular operation) or in temporary transportable setups, a map display is useful for showing the current receiver position (R&S®EB500-Map option).

The digital map (e.g. based on OpenStreetMap (OSM) maps) shows, for example, the points where values were measured, as well as direction information if bearings are available and the current position of the receiver.

The recorded measured values are displayed after selecting a specific point, e.g. the spectrum recorded at a certain intersection in an urban area. This function helps to identify interference so that the source of the problem can be promptly eliminated.

The R&S®EB500-Map option is available for receivers with front panel operation (model .03) or for external R&S®EB500-GUI software.

Polychrome spectrum to distinguish superimposed, pulsed signals

The polychrome spectrum display makes it possible to separate superimposed, pulsed signals that cannot be differentiated using conventional methods (e.g. spectrum, waterfall, max. hold).

The difficulty with superimposed, pulsed signals is that they occur at the same time and frequency in the spectrum and possibly have a similar level.

To differentiate complex signal scenarios of this kind, the receiver analyzes the frequency of occurrence of each individual signal and displays the results over frequency in a color-coded diagram.

Signals shown in red occur more frequently than signals shown in green or blue. The occurrence frequency threshold can be predefined by the user and is shown on the receiver as the 100% time.

The polychrome spectrum is very useful for signal separation, for example to extract pulsed interfering signals superimposed on pulsed wanted signals (GSM, DECT).

This function is included in the base unit.

Superimposed, pulsed signals (here: GSM900 downlink) are displayed in different colors based on how often they occur and can be more easily analyzed than in the max. hold view.

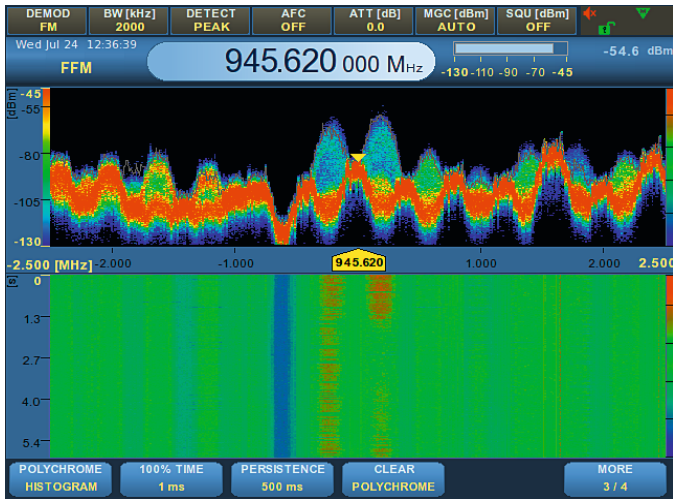

A low-amplitude pulsed signal (Bluetooth®) superimposed with a higher-amplitude pulsed signal (WLAN): The polychrome spectrum shows pulse timing differences.

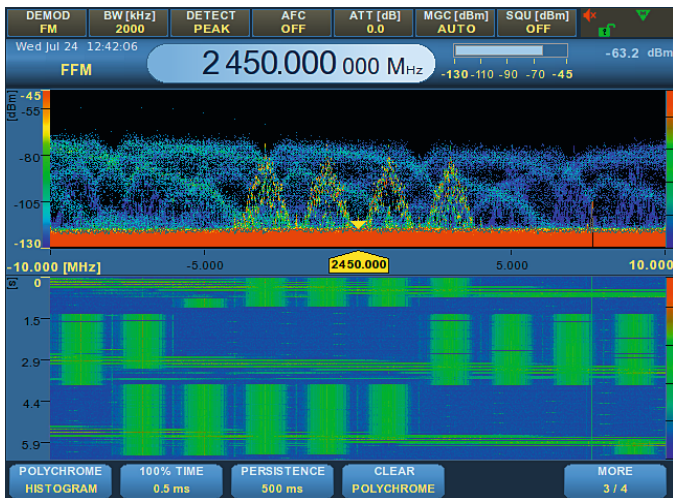

Video spectrum for display of subcarriers and transmission rates

The video spectrum is used to display the demodulated received signal (RF carrier removed through demodulation). The remaining envelope (in the time domain) is displayed as a spectrum (in the spectral domain).

As a result, existing subcarriers, such as the 19 kHz pilot tone in FM radio signals, are presented in a clear, visually stable display.

The squared video spectrum permits quick and easy analysis of digitally modulated signals. Due to the squaring, the received signal has peaks to the right and left of the center frequency. The spacing between the peaks and the center frequency is a measure of the rate at which a received digital channel is transmitted (baud rate). The existing transmission rate can be easily and conveniently estimated without additional software.

The video spectrum can be combined with the waterfall display.

This function is included in the base unit.

Display of the subcarriers of an FM radio signal using an FM-demodulated video spectrum (pilot tone: 19 kHz; RDS signal: 56 kHz from center frequency).

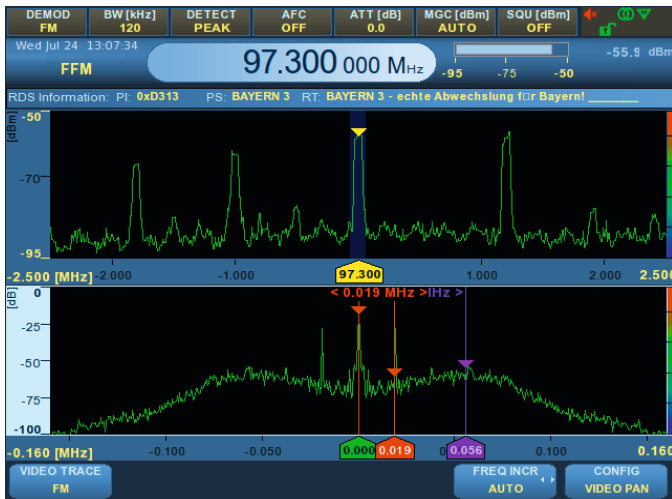

Transmission rate estimate of a TETRA signal using a squared video spectrum (signal peaks approx. 18 kHz from center frequency; transmission rate approx. 18 kBd).



Parallel signal processing of spectral path and demodulation path

After A/D conversion of the received signal, the R&S®EB500 splits up signal processing into two parallel paths: the spectral path and the demodulation path or level measurement path.

As a result, demodulation and level measurements on signals within the realtime spectrum can be performed simultaneously and while being displayed in the realtime spectrum.

Audio signals are demodulated with interference-free audible content since the R&S®EB500 does not need to switch between spectral and audio processing.

A seamless I/Q data stream is available for I/Q baseband demodulation – a vital processing step for subsequent signal analysis with analysis software.

Parallel signal processing permits users to simultaneously work with different bandwidth settings: wideband for a spectral overview and narrowband for demodulation and level measurements of a specific signal within the realtime bandwidth.

The center frequency of the realtime spectrum and demodulator/level detector can be set independently of each other. Demodulation will only work if the frequency of the signal of interest is within the selected realtime spectrum.

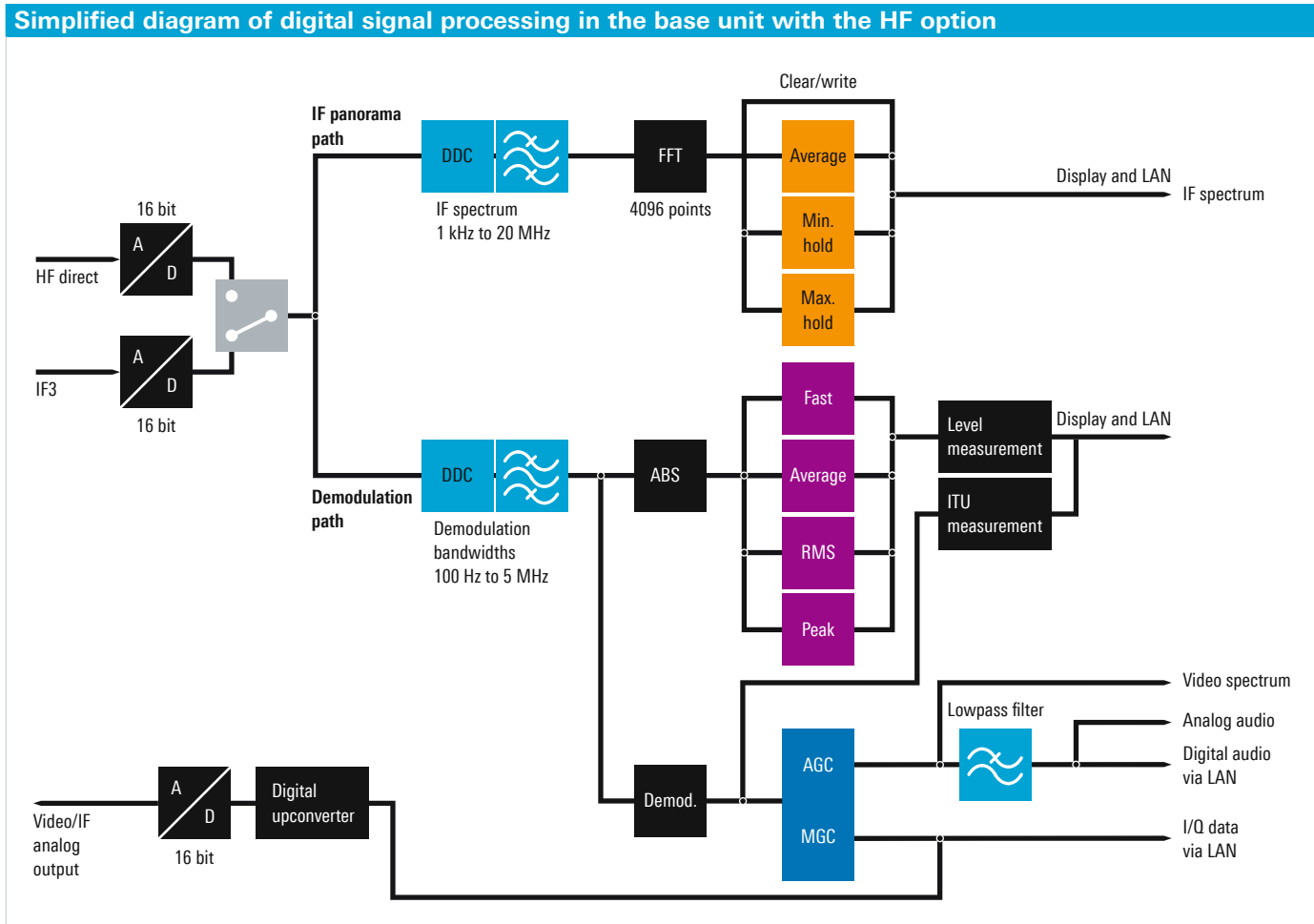

Level measurements with “real” wideband detector

The level of received signals is measured using a “real” wideband detector instead of the calculated FFT spectrum. Results are no longer corrupted due to FFT windowing, and it is no longer necessary to postprocess the level value (e.g. using a correction table).

The detector processes signals extremely fast, and even the signal levels of short-term pulses (less than a few hundred nanoseconds) can be accurately measured.

The high measurement bandwidth of up to 20 MHz is ideal for measuring the signal level of modern, digitally modulated signals, such as:

- DVB-T (approx. 8 MHz)
- LTE (up to 20 MHz)

Frequency scan and memory scan for audio demodulation on changing channels

The frequency scan (FScan) and memory scan (MScan) modes included in the base unit can be used to check if certain radio services are occupied (level exceeds squelch) and, if emissions are detected, to dwell on this channel for a preset period of time, for example to output demodulated audio information.

The frequency scan mode should be used to scan radio services with specific parameters, e.g. ATC radio bands with fixed channel spacing, bandwidth and demodulation mode.

Due to its flexibly parameterized memory locations, the memory scan is ideal for scanning several different radio services (e.g. ATC, PTT) in a single scan. Demodulation parameters and channel spacing are variably programmable.

Both scan modes allow users to conveniently search for active signals that are expected to occur in quick succession on different channels, and ensure that audio content is quickly available.

Uncorrupted level measurement of a wideband LTE signal using the wideband RMS detector.



For audio demodulation, the ATC radio band is examined in 25 kHz steps to detect signals that exceed the squelch level.

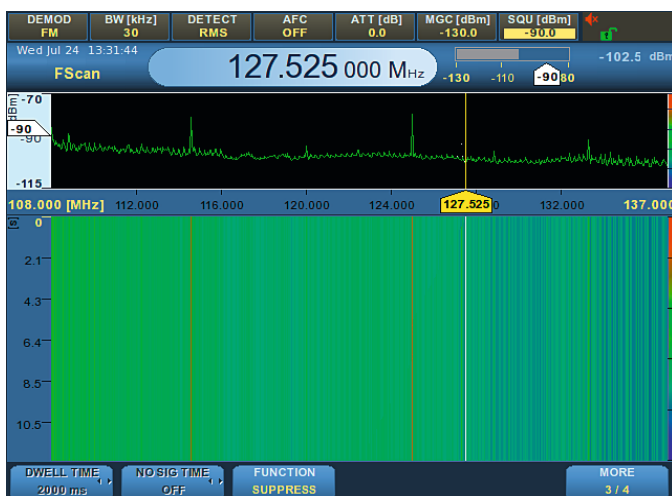

3+1 receivers in one instrument

Equipped with the R&S®EB500-DDC option, the R&S®EB500 offers three parallel demodulation channels in addition to the demodulation path included in the base unit.

The demodulation path included in the base unit has a maximum bandwidth of 20 MHz; the three additional paths provide a maximum of 1 MHz each. When the R&S®EB500-DDC option is installed, users have four independent software receivers in a single instrument.

The demodulated information from all four channels is processed as separate data streams via the LAN interface, e.g. as a *.wav data stream for audio data or as I/Q base-band data for analysis.

The four demodulation channels can be placed anywhere within the selected realtime bandwidth and separately parameterized. Settable parameters include:

- Center frequency
- Bandwidth
- Demodulation mode
- Squelch value

Using the DDC function, users can process four signals in parallel and check for content or absence of interference.

Ethernet interface for remote control and/or data transmission

The base unit is equipped with a 1 Gbit LAN interface to control the monitoring receiver from a remote operator workstation and to output measurement results. System and analysis software packages from Rohde & Schwarz, such as R&S®ARGUS, R&S®RAMON and R&S®CA100, access this interface to utilize all receiver functions.

The open interface description for remote control commands (in line with the SCPI standard) and the output data formats enable external system integrators to incorporate the receiver into third-party software solutions.

3+1 demodulation channels with different parameters within the realtime bandwidth.

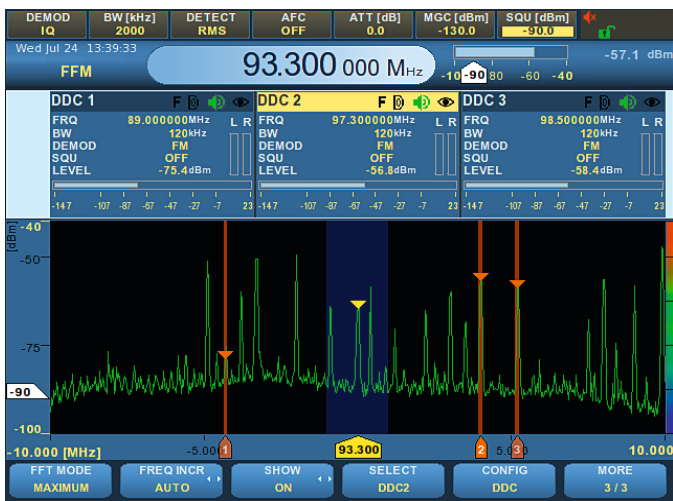

LAN interface for remote control and/or data transmission



1 Gbit LAN interface for remote control and/or data transmission on the receiver's rear panel

Receiver remote control and data recording

The base unit comes with the R&S®EB500-Control software package for remotely controlling the receiver via the 1 Gbit LAN interface. All functions are available, from tuning the receiver to a center frequency and parameterizing the realtime spectrum to starting the fast spectral scan. R&S®EB500-Control records all results, including spectra, waterfall, demodulated audio information and I/Q base-band data, to the remote controller's hard disk.

It is possible to replay recorded data for offline analysis (I/Q data processing, e.g. with R&S®CA100 or MATLAB®).

The R&S®EB500-Control software package provides a point-to-point connection between a PC and a receiver. The R&S®RAMON software extends the functionality to create a system solution (e.g. connecting several users to one receiver).

Realtime spectrum and waterfall display of a radar signal from Singapore airport.

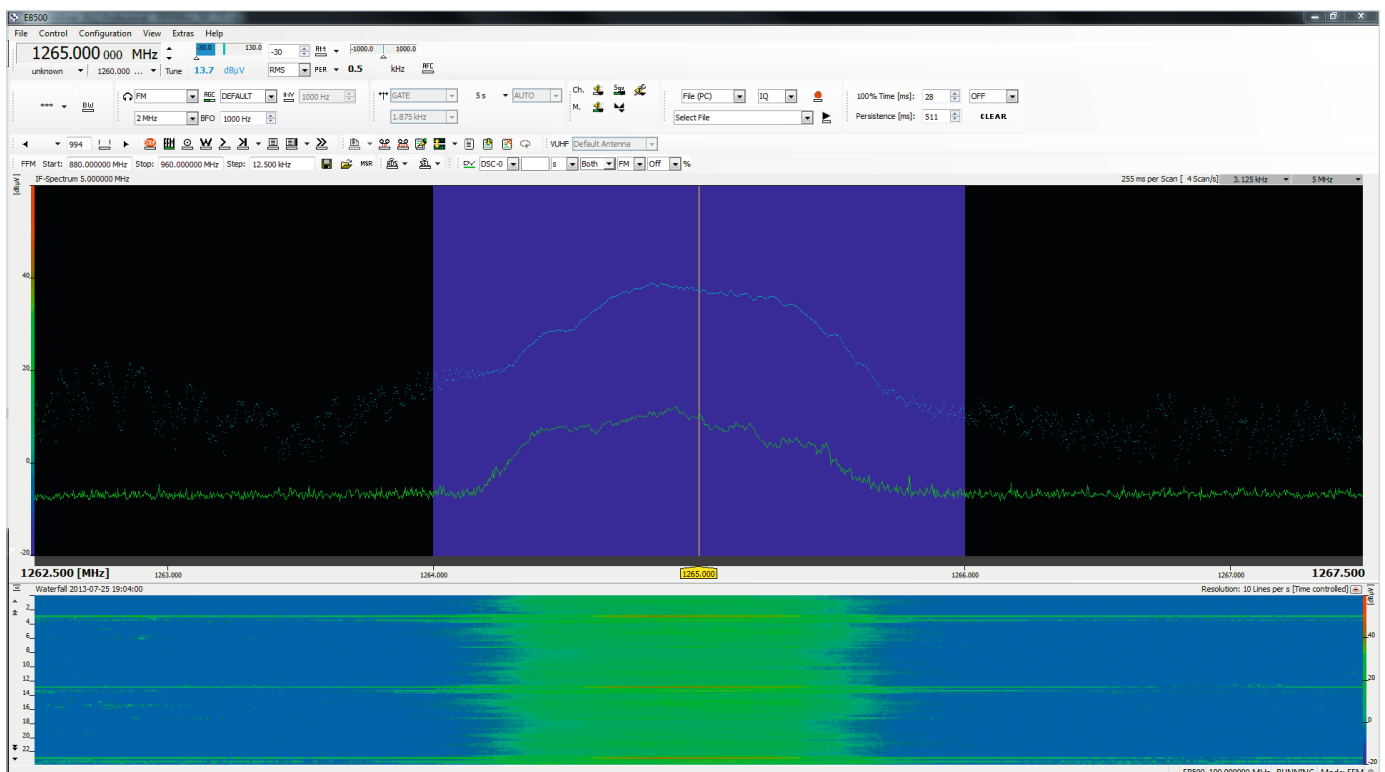

ITU-compliant measurements in the receiver

The R&S®EB500-IM option enables ITU-compliant measurements of signal parameters for AM, FM and PM-modulated signals. The modulation index, occupied bandwidth and phase deviation can be determined, for example. The minimum, maximum and average values over a user-defined measurement period are displayed. The R&S®EB500-IM option covers the following ITU recommendations:

- ITU-R SM.377 (frequency and frequency offset measurements)
- ITU-R SM.378 (field strength measurements)
- ITU-R SM.328 (bandwidth measurements)
- ITU-R SM.443 (bandwidth measurements)
- ITU-R SM.1880 (determination of spectral occupancy, with remote control PC and R&S®ARGUS software package)

For offline measurement of digitally modulated signals in line with ITU-R SM.1600, the R&S®CA100IS option can be added to the R&S®CA100 software solution (requires an additional PC).

The R&S®EB500 fulfills the following ITU hardware recommendations:

- ITU-R SM.1836 (measurements of IF filter edge steepness)
- ITU-R SM.1837 (IP3 measurements)
- ITU-R SM.1838 (noise figure measurements)
- ITU-R SM.1840 (sensitivity measurements)

Modulation and bandwidth measurement results at a glance.



Offline measurement of a Digital Radio Mondiale (DRM) signal in line with ITU-R SM.1600.

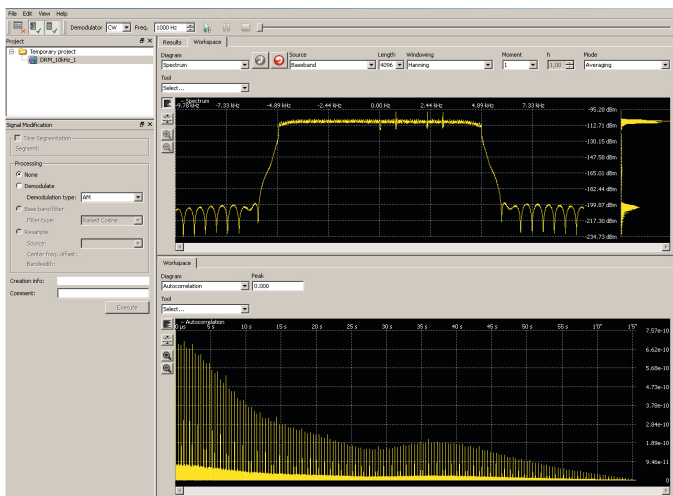

Display of detected selective call standards in an overview list (left column); filtering by relevance possible (right column).

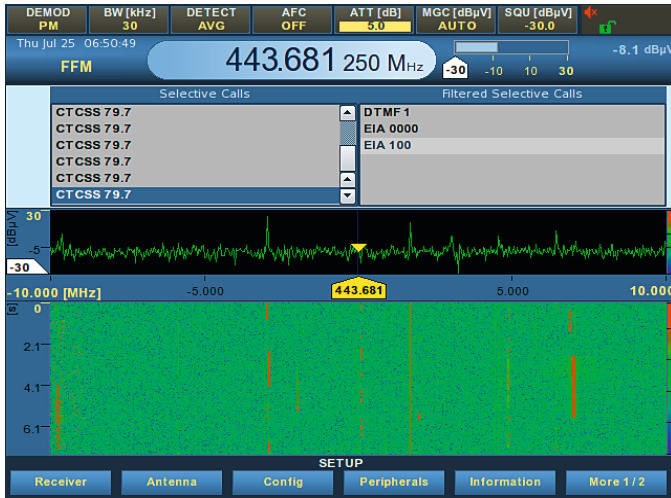

Detection of selective call services

The R&S®EB500-SL option is available for detecting active selective call services. The receiver automatically scans all emissions within the demodulation bandwidth and displays detected selective call services. The results can be filtered based on relevance. The R&S®EB500 supports the following selective call services, for example:

- DTMF
- CCIR
- CTCSS
- ZVEI-x

This function is of particular importance for regulatory authorities that use sampling to monitor the proper use of specific allocated call services.

DC operation (e.g. from vehicle battery)

The R&S®EB500 receives its power directly from a DC source, such as a vehicle battery. Thanks to its wide input voltage range from 10 V to 32 V DC, the receiver can be operated on both car and truck batteries. The DC power supply is integrated directly in the receiver; no additional space is required for in-vehicle installation. An accessory cable is available that has a connector for the receiver plus cable lugs for the vehicle's on-board power supply (R&S®EB500-DCC DC power cable).

DC port for connecting the R&S®EB500 to the vehicle's on-board power supply



System time synchronization using NTP server

An NTP server distributes the system time to all devices in the networked system. Synchronization takes place automatically every time when the receiver starts up, or can be manually triggered by an SCPI command issued by the user or a software application running on the network. The internal device time and date are synchronized to the received NTP time. The accuracy depends on the quality of the NTP server and LAN infrastructure and is typically in the millisecond range. Cyclic synchronization of device time and date prevents drifting differences in the internal time references of multiple receivers in the network.

An NTP server distributes time and date information to the receivers in the system via a network connection

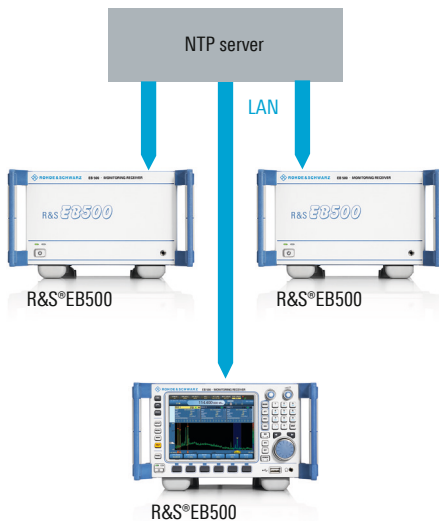

The synchronized timebase makes it easier to compare measurement results received by different stations (e.g. spectrum, audio). As a result, it is possible to identify and assign results with identical timestamps. It is also possible to document when a specific signal, e.g. an interfering signal, was received.

TDOA ready with high-accuracy timestamps and GPS synchronization of frequency and time

The R&S®EB500 system time can be set and synchronized via the external GPS module's NMEA protocol. GPS information, e.g. position and date, is available at the LAN interface.

The internal R&S®EB500 10 MHz reference frequency is synchronized using a pulse per second (PPS) signal from the GPS module. The GPS module significantly improves the accuracy of the internal reference frequency to fulfill all ITU frequency accuracy requirements ($\leq 1 \times 10^{-9}$) for radiomonitoring receivers:

- Typ. 1×10^{-11} (with external GPS module, R&S®EB5-EGT option)

The receiver's high-accuracy timestamp in the I/Q output data stream is also derived from the information in the GPS module. The accuracy of the timestamp is in the nanosecond range (with external GPS module, R&S®EB5-EGT option).

The timestamps in the I/Q baseband data stream of the R&S®EB500 permit TDOA ¹⁾ applications via LAN. The R&S®EB500 functions as a receiving node in the sensor network. Time accuracy depends on the receiver's antenna input and is independent of the receiver settings, which significantly simplifies the setup of correction tables for a TDOA system. The tables only need to contain system parts such as antennas, cable lengths and signal distribution, and not all receiver settings. This greatly simplifies the TDOA system integrator's job.

The time accuracy in the baseband data stream (when using the external GPS module) leads to extremely reliable radiolocation results in the TDOA network.

¹⁾ TDOA: time difference of arrival.

R&S®EB5-EGT external GPS module.



Detailed display of GPS data and GPS operating mode.

| Name | Latitude | Longitude | Altitude |
|------|------------|------------|----------|
| CBP | N01.338... | E103.96... | 38.50 m |

Operation Mode: Averaging
 Averaging Accuracy: 5.00 m
 Averaging min Observation Time: 1200 s
 Antenna Cable Length: 6.00 m
 Antenna Type: Active
 Edge for Pulse: Rising
 Cold Reset: [Button]
 Load: [Button] Delete: [Button] Delete All: [Button] Details: [Button]

Current Location: Name: [Field] Save: [Button]
 Location: N01.338691° E103.964816° 46.20 m
 Satellites: 6 HDOP: 1.37
 Avg Time: 00:01:42 Avg Std Dev: 2.78 m
Fixed Location: Name: [Field] Save: [Button]
 Latitude: North 1 338456 °
 Longitude: East 103 964483 °
 Altitude (MSL): 25.50 m

PERIPHERALS
 Declination: [Field] Location: [Field] EGT: [Field] More (2 of 2)

Single-channel direction finder upgrade kit

The R&S®EB500-DF and R&S®EB500-WDF (wideband DF with realtime bandwidth of up to 20 MHz) options turn the monitoring receiver into a single-channel direction finder (on a single frequency). Simultaneous direction finding of all emissions within the realtime bandwidth has many advantages:

- Simultaneous direction finding and display of all occupied channels, e.g. in the aeronautical or maritime radio bands
- DF measurements on wideband signals (e.g. DVB-T) with high channel resolution, display of DF result as average value calculated from many individual bearings (to compensate for frequency-dependent bearing fluctuations)
- Reliable DF results for frequency agile transmitters (hoppers or chirp signals)

DF result shown on a DF compass rose for wideband signals.

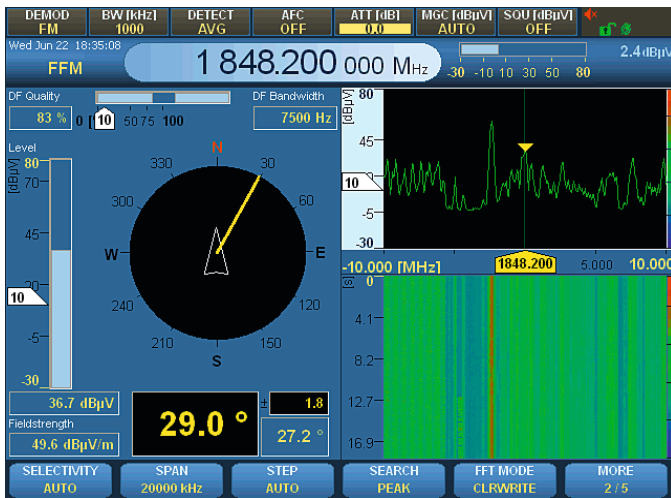

Depending on the antennas used, these options can be used to take the bearings of frequencies between 8 kHz and 6 GHz. In the HF range, the Watson-Watt direction finding method is used. The special advantage of this method is that small DF antennas can be deployed. As a result, the R&S®EB500 is ideal for taking bearings during mobile operation in vehicles.

In the VHF/UHF range, the R&S®EB500 uses the correlative interferometer DF method. In contrast to simple amplitude comparison methods, the instrument offers significantly higher DF accuracy up to class A/B in line with the ITU spectrum monitoring handbook and recommendations.

Most interferometer direction finders on the market use at least two receivers. With the R&S®EB500, the two receive paths are coherently linked in the DF antenna using a patented Rohde & Schwarz method. There is no need for a second interception processing channel that is customarily found in interferometer direction finders.

Documentation of calibration values

The R&S®EB500-DCV documentation of calibration values option provides the user with the calibration certificate for a specific instrument according to the serial number. During final production testing, the instrument's measured values are compared with the permissible (min./max.) limits. The DCV report demonstrates the instrument's compliance with specifications. The document comes with a removable label for the instrument that clearly indicates the compliance period.

| Kalibrierschein Calibration Certificate | | Nummer Number | 71-437672 |
|---------------------------------------------------------------|-------------------------------------------|------------------------------------------------------------------------------------------------------------------------------------------------------------------------------------------------------------------------------------------------------------------------------------------------------------------------------------------------------------------------------------------------------------------------------------------------------------------------------------------------------------------------------------------------------------------------------------------------------------------------------------------------------------------------------------------------------------------------------------------------------------------------------------------------------------------------------------------------------------------------------------------------------------------------------------------------------------------------------------------------------------------------------------------------------------------------------------------------------------------------------------------------------|-----------|
| Gegenstand Item | EB500 MONITORING RECEIVER | Dieser Kalibrierschein dokumentiert, dass der genannte Gegenstand nach festgelegten Vorgaben geprüft und gemessen wurde. Die Messwerte liegen im Regelfall mit einer Wahrscheinlichkeit von annähernd 95% im zugeordneten Wertebereich (Erweitertes Messunsicherheitsmaß mit $k = 2$). Die Kalibrierung erfolgte mit Messmitteln und Normen, die direkt oder indirekt durch Ableitung mittels anerkannter Kalibriertechniken rückgeführt sind auf Normale der PTB/DKD oder anderer nationaler/internationaler Standards zur Darstellung der physikalischen Einheiten in Übereinstimmung mit dem Internationalen Einheitensystem (SI). Wenn keine Normale existieren, erfolgt die Rückführung auf Bezugsnormale der R&S-Laboratorien. Grundsätze und Verfahren der Kalibrierung entsprechen EN ISO/IEC 17025. Das angewandte Qualitätsmanagement-System ist zertifiziert nach EN ISO 9001. Dieser Kalibrierschein darf nur vollständig und unverändert weiterverbreitet werden. Kalibrierscheine ohne Signifizierungen sind ungültig. Für die Einhaltung einer angemessenen Frist zur Wiederholung der Kalibrierung ist der Benutzer verantwortlich. | |
| Hersteller Manufacturer | ROHDE & SCHWARZ | This calibration certificate documents, that the named item is tested and measured against defined specifications. Measurement results are located usually in the corresponding interval with a probability of approx. 95% (coverage factor $k = 2$). Calibration is performed with test equipment and standards directly or indirectly traceable by means of approved calibration techniques to the PTB/DKD or other national / international standards, which realize the physical units of measurement according to the International System of Units (SI). In all cases where no standards are available, measurements are referenced to standards of the R&S laboratories. Principles and methods of calibration correspond with EN ISO/IEC 17025. The applied quality system is certified to EN ISO 9001. This calibration certificate may not be reproduced other than in full. Calibration certificates without signatures are not valid. The user is obliged to have the object recalibrated at appropriate intervals. | |
| Typ Type | EB500 | | |
| Material Nr. Material number | 4072.5004K03 | | |
| Serial Nr. Serial number | 101072 | | |
| Auftraggeber Customer | | | |
| Bestellung Nr. Order number | | | |
| Ort u. Datum d. Kalibrierung Place and date of calibration | Singapore, 2013-06-18 | | |
| Umfang der Kalibrierung Scope of calibration | Standard Calibration | | |
| Eingangsprüfung Performance on receipt | New device | | |
| Kalibrierergebnis Result of calibration | Measurement results within specifications | | |
| Umfang des Kalibrierscheins Extent of the certificate | 2 pages incl. this | | |
| | | | |
| ROHDE & SCHWARZ Nr. 71-437672 2013-06-18 | | | |
| Ausstellungsdatum Date of issue | Laborleitung Head of laboratory | Bearbeiter Person responsible | |
| 2013-06-18 | | | Page 1/2 |

Documentation of calibration values; example of an R&S®EB500-DCV calibration certificate (cover sheet).

Specifications in brief

| Specifications in brief | | |
|----------------------------------------|-------------------------------------------------------------------------|--------------------------------------------------------------------------------------------------------------------------------------------------------------------------------------------------------------------------------------------------------------------------------------------------------|
| Frequency | | |
| Frequency range, receive mode | base unit | 20 MHz to 3.6 GHz |
| | with R&S®EB500-HF option | 8 kHz to 3.6 GHz |
| | with R&S®EB500-FE option | 20 MHz to 6 GHz |
| | with R&S®EB500-HF and R&S®EB500-FE options | 8 kHz to 6 GHz |
| IF bandwidths | | |
| Bandwidth | demodulation, level and offset measurement (3 dB bandwidth), 34 filters | 100/150/300/600 Hz, 1/1.5/2.1/2.4/2.7/3.1/4/4.8/6/9/12/15/30/50/120/ 150/250/300/500/800 kHz, 1/1.25/1.5/2/5/8/10/12.5/15/20 MHz |
| Demodulation | | |
| Demodulation modes | all IF bandwidths | AM, FM, φM, pulse, ISB, I/Q |
| | IF bandwidths ≤ 8 kHz | LSB, USB, CW, ISB |
| Realtime spectrum (IF panorama) | | |
| FFT spectrum | | gap-free, dynamically overlapping FFT operating mode: automatic or variable with selectable frequency resolution 0.625/1.25/2.5/3.125/6.25/12.5/25/31.25/50/ 62.5/100/125/200/250/312.5/500/ 625 Hz, 1/1.25/2/2.5/3.125/5/6.25/8.333/10/12.5/20/25/ 50/100/200/500 kHz, 1 MHz, 2 MHz |
| Spectrum span | base unit | 1/2/5/10/20/50/100/200/500 kHz, 1/2/5/10/20 MHz |
| Spectrum display | | clear/write, average, max. hold, min. hold, histogram, pulse |
| Scan characteristics | | |
| Memory scan | | 10 000 programmable memory locations |
| | speed | up to 500 channels/s |
| Frequency scan | | user-selectable start/stop frequency and step size |
| | speed | up to 500 channels/s |
| Fast spectral scan (panorama scan) | with R&S®EB500-PS option | spectral scan with user-selectable start/stop frequency, step size (bin): 100/125/200/250/500/625 Hz, 1/1.25/2/2.5/3.125/5/6.25/8.333/10/12.5/20/25/ 50/100/200/500 kHz, 1 MHz, 2 MHz |
| | speed | up to 75 GHz/s (in-band) |

Ordering information

| Designation | Type | Order No. |
|----------------------------------------------------|---------------|--------------|
| Monitoring Receiver, without front panel control | R&S®EB500 | 4072.5004.02 |
| Monitoring Receiver, with front panel control | R&S®EB500 | 4072.5004.03 |
| Documentation of Calibration Values | R&S®EB500-DCV | 4072.8403.02 |
| Options | | |
| HF Frequency Range Extension, 8 kHz to 32 MHz | R&S®EB500-HF | 4072.8003.02 |
| SHF Frequency Range Extension, 3.6 GHz to 6 GHz | R&S®EB500-FE | 4072.9300.02 |
| Panorama Scan | R&S®EB500-PS | 4072.9200.02 |
| Internal Recording | R&S®EB500-IR | 4072.9551.02 |
| Map Display | R&S®EB500-Map | 4072.9451.02 |
| ITU Measurement Software | R&S®EB500-IM | 4072.9100.02 |
| Selective Call Analysis | R&S®EB500-SL | 4072.9800.02 |
| Digital Downconverter | R&S®EB500-DDC | 4072.9500.02 |
| Direction Finder Upgrade Kit | R&S®EB500-DF | 4072.9400.02 |
| Wideband Direction Finding | R&S®EB500-WDF | 4072.9651.02 |
| DF Error Correction | R&S®EB500-COR | 4072.9600.02 |
| External GPS Module | R&S®EB5-EGT | 4073.2009.02 |
| Recommended extras | | |
| 19" Rack Adapter (2 × R&S®EB500 side by side) | R&S®ZZA-T04 | 1109.4187.00 |
| 19" Rack Adapter (1 × R&S®EB500 + 1 × blind plate) | R&S®ZZA-T02 | 1109.4164.00 |
| DC Power Cable | R&S®EB500-DCC | 4072.7036.00 |

| Service options | | |
|----------------------------------------------------------|---------|-----------------------------------------------------------------|
| Extended Warranty, one year | R&S®WE1 | Please contact your local Rohde & Schwarz sales representative. |
| Extended Warranty, two years | R&S®WE2 | |
| Extended Warranty, three years | R&S®WE3 | |
| Extended Warranty, four years | R&S®WE4 | |
| Extended Warranty with Calibration Coverage, one year | R&S®CW1 | |
| Extended Warranty with Calibration Coverage, two years | R&S®CW2 | |
| Extended Warranty with Calibration Coverage, three years | R&S®CW3 | |
| Extended Warranty with Calibration Coverage, four years | R&S®CW4 | |

The Bluetooth® word mark and logos are registered trademarks owned by Bluetooth SIG, Inc. and any use of such marks by Rohde & Schwarz is under license.



ООО «4TECT»

Телефон: +7 (499) 685-4444

info@4test.ru

www.4test.ru